



Leica DM750 P

Student Friendly in Every Way:
The New Generations Choice of an Innovative Educational Microscope

Living up to Life

Leica
MICROSYSTEMS

Earth Science Teaching Revitalized

The more time an instructor has to teach, the more students can learn. The Leica DM750 P polarizing microscope was specifically developed to revitalize earth science teaching and to achieve the goal of more hands-on time for Earth and Materials Science courses. With many student-friendly features and high-quality construction, the Leica DM750 P is the right tool to invigorate Petrography, Crystallography, and Materials Science learning and teach the next generation of scientists effectively and efficiently.

Superb Optics

- Based on the same optical platform as Leica Microsystems' research microscope line, students enjoy outstanding optical performance and full access to virtually all accessories from the Leica Microsystems microscope product line.
- Strain-free objectives and condensers make the sample the only part effecting the polarized light.

EZStore™

- Integrated vertical handle provides easy carrying and easy lifting when storing on high shelves; undercut on front of stand works in combination with the handle for safer, two-handed carrying.
- Integrated cord wrap eliminates damage to microscope components from improper cord wrapping; vertical cord insertion prevents the cord from pulling partially out of the stand while in storage or in use.
- Onboard storage of accessories to prevent loss.
- The unique shape of the microscope stand protects controls from damage when microscopes are stored side-by-side.

AgTreat™

- The spread of disease from surfaces is of great concern, especially in educational environments. Leica Microsystems has integrated an additive so that all microscope touch points are treated to inhibit the growth of bacteria. This helps to prevent the spread of disease via the microscope surfaces and leads to a healthier laboratory environment.



DM750 P

The future is now

The DM750 P is designed specifically for the versatile needs of Earth and Material Science Courses.



Simplicity

- Analyzer module to accommodate analyzer sliders for basic polarisation microscopy.
- Conoscopy analyzer/Bertrand lens module with upfront clearly labeled flip in/flip out controls to prevent dust damage and confusion of operation. Bertrand lens is easily centerable with the provided tool (stored in module).
- Conoscopy advanced analyzer/Bertrand lens module also provides a focusable Bertrand lens to fine tune the focus of the Conoscopic Image for different magnifications.
- Onboard storage locations for two nosepiece compensators and the objective centering tools to prevent loss.



Ready to work

- Large 178mm diameter stage for easy specimen placement and viewing of calibrations.
- Brake for locking the stage in position.
- Object guide for precise X/Y positioning of the specimen.
- Laser engraved stage eliminates the chance for the stage calibrations to rub off over time.



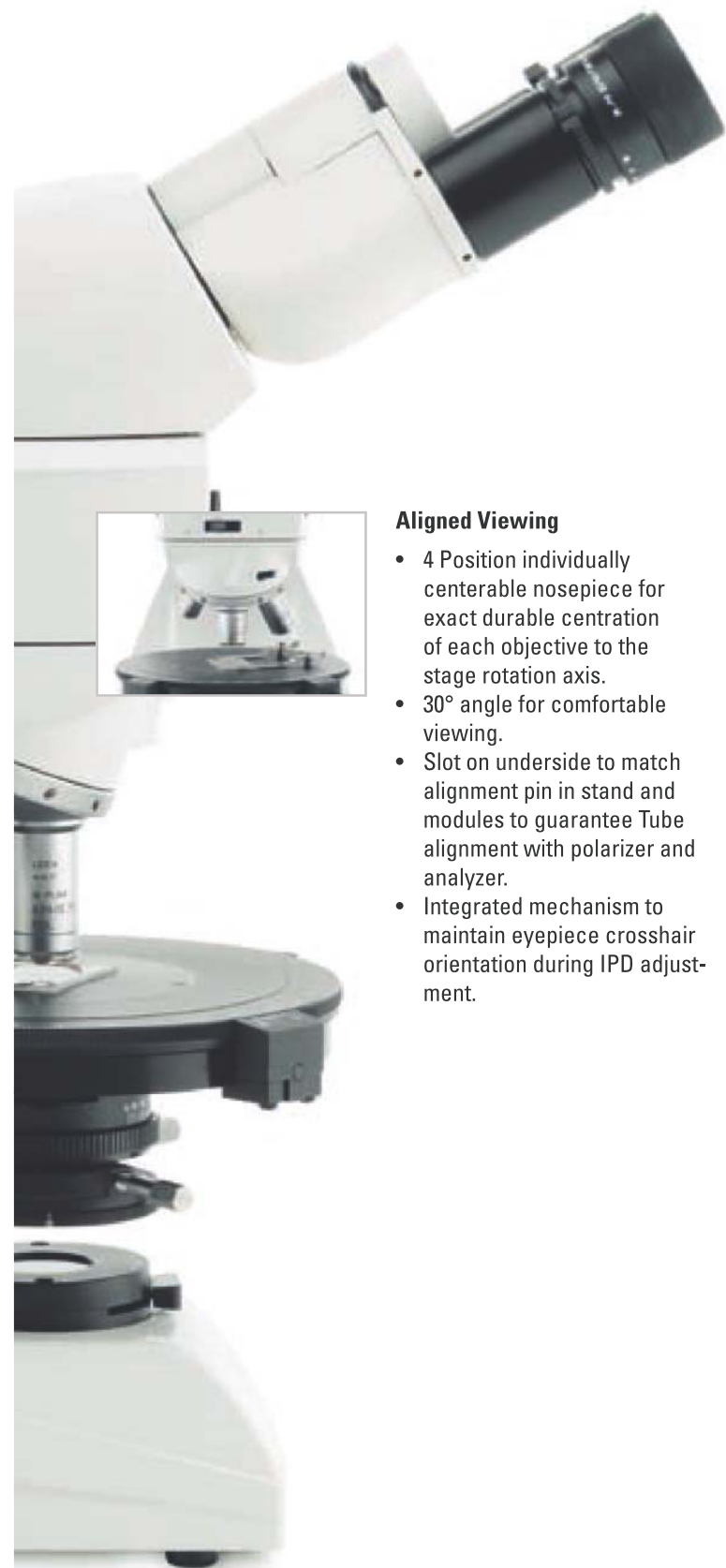

Aligned Viewing

- 4 Position individually centerable nosepiece for exact durable centration of each objective to the stage rotation axis.
- 30° angle for comfortable viewing.
- Slot on underside to match alignment pin in stand and modules to guarantee Tube alignment with polarizer and analyzer.
- Integrated mechanism to maintain eyepiece crosshair orientation during IPD adjustment.



Optional Reflected Light

- Reflected light illuminator with capability for brightfield, polarized light, and Bertrand lens so all reflected and transmitted light techniques can be used with one configuration.
- Patented stage well for tall samples allow the viewing of polished materials in mounts thicker than 17mm.



Perfect light

- Bright 35W halogen illumination for intense images under polarized light.
- Long life 2,000 hour lamp saving cost and time in lamp replacements
- Koehler field diaphragm for optimum illumination and contrast.
- Magnetic attachment daylight filter for viewing under natural color conditions, yet easily removable if a warmer colored illumination is preferred. Daylight filter "disappears" into field diaphragm assembly to prevent loss.



Versatility

- Strain free standard condenser for magnifications 4x – 100x with slot for ¼ wave compensator for circular polarization technique.
- Flip Top condenser for low magnifications.
- Aperture diaphragm with marks for the correct position of typical objective magnifications for intuitive learning and operation.

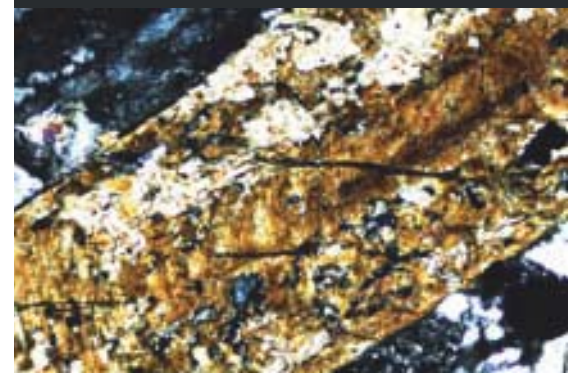
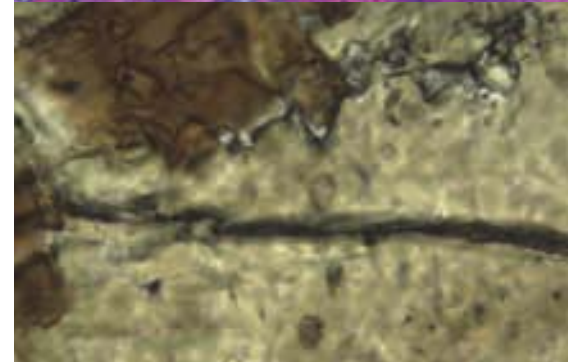
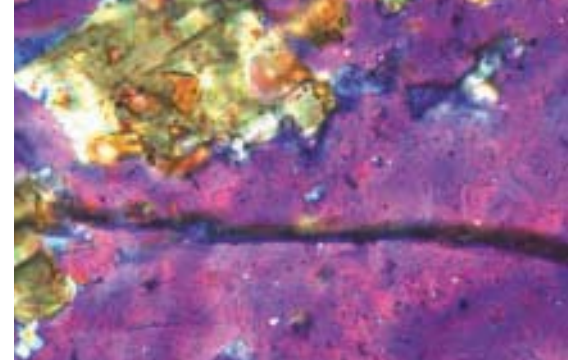
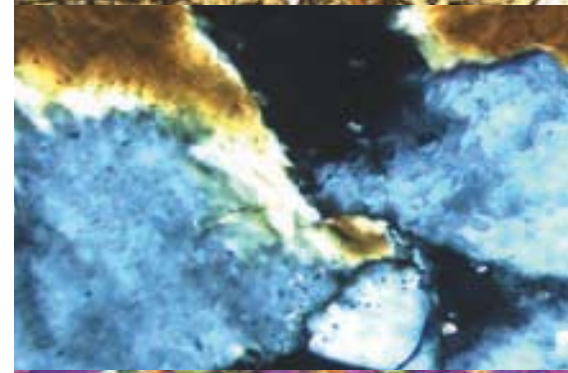
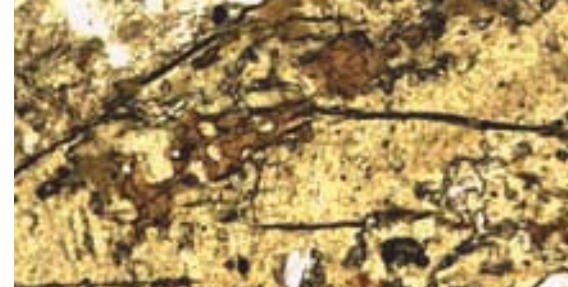

The ability to share, capture, and archive images is becoming an important part of the microscopy laboratory. Now available: the full range of Leica Microsystems imaging solutions.

Leica Imaging

- A new trinocular viewing tube and C-mount adapters provide the versatility to use stand-alone cameras which opens the door to unlimited imaging possibilities.
- A variety of Leica digital cameras with different sensors provide high resolution pictures and fast live images.
- Includes Leica Application Suite (LAS) software for easy camera control, image capture, annotation, measurement and documentation.
- Customize your own Imaging Solution using a wide selection of optional Leica Microsystems software modules.
- Store and recall: A "never-lost" module for instantly perfect results for all samples.
- The modular design of the system allows easy upgrades and service.



A New Approach to Imaging



Dimensions Leica DM750 P

Dimensions in mm/inch

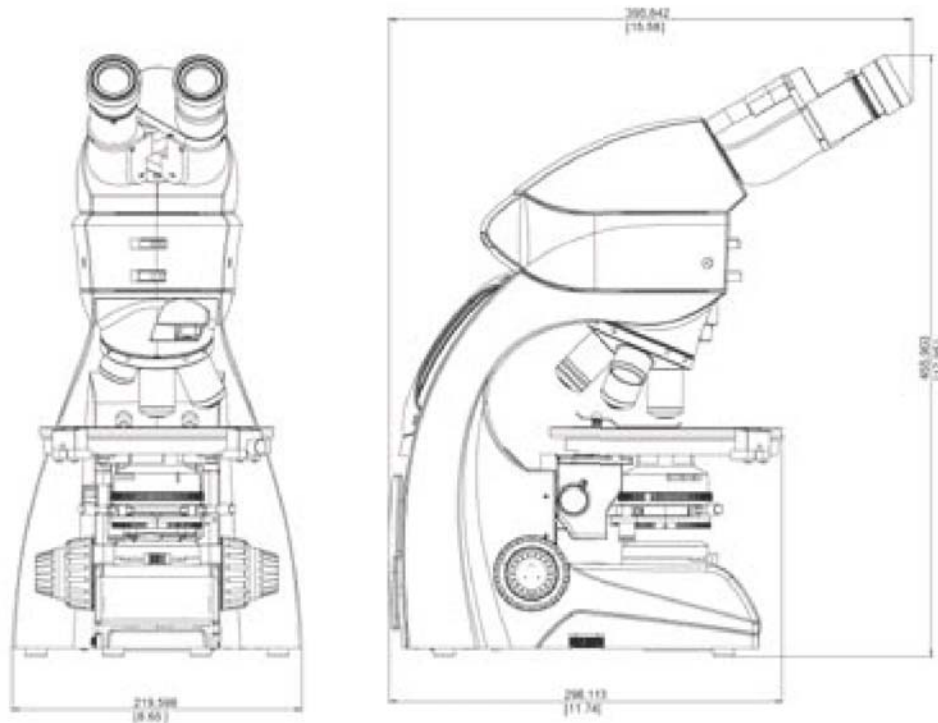

Preconfigured Outfits Leica DM750 P

OUTFIT ORDERING NUMBER		13613600	13613601
STAND		DM750 P	DM750 P
13 613 610	DM750 P Stand Koehler, 4 position centerable nosepiece	X	X
TUBES			
13 613 621	30° Binocular Ppl Tube	X	X
EYEPIECES			
13 613 532	10x/20 focusing eyepiece with eyeguard	X	X
13 613 630	10x/20 focusing eyepiece with eyeguard, Crosshair reticle, and key for orientation	X	X
POL MODULES			
13 613 660	Analyzer/Bertrand Lens Module	X	X
COMPENSATORS			
13 586 006	Lambda Compensator full wave plate	X	X
CONDENSERS			
13 613 650	Pol Abbe Condenser 0.85	X	X
POL OBJECTIVES			
11 556 060	HI Plan Pol 4x/0.10 NA, 18.0mm W.D.	X	X
11 556 061	HI Plan Pol 10x/0.25 NA, 12.0mm W.D.	X	X
11 556 065	HI Plan Pol 40x/0.65 NA, 0.36mm W.D.	X	
11 556 066	HI Plan Pol 63x/0.75 NA, 0.31mm W.D.		X
POWER CORD NOT INCLUDED: Must be ordered separately			

System diagram Leica DM750 P

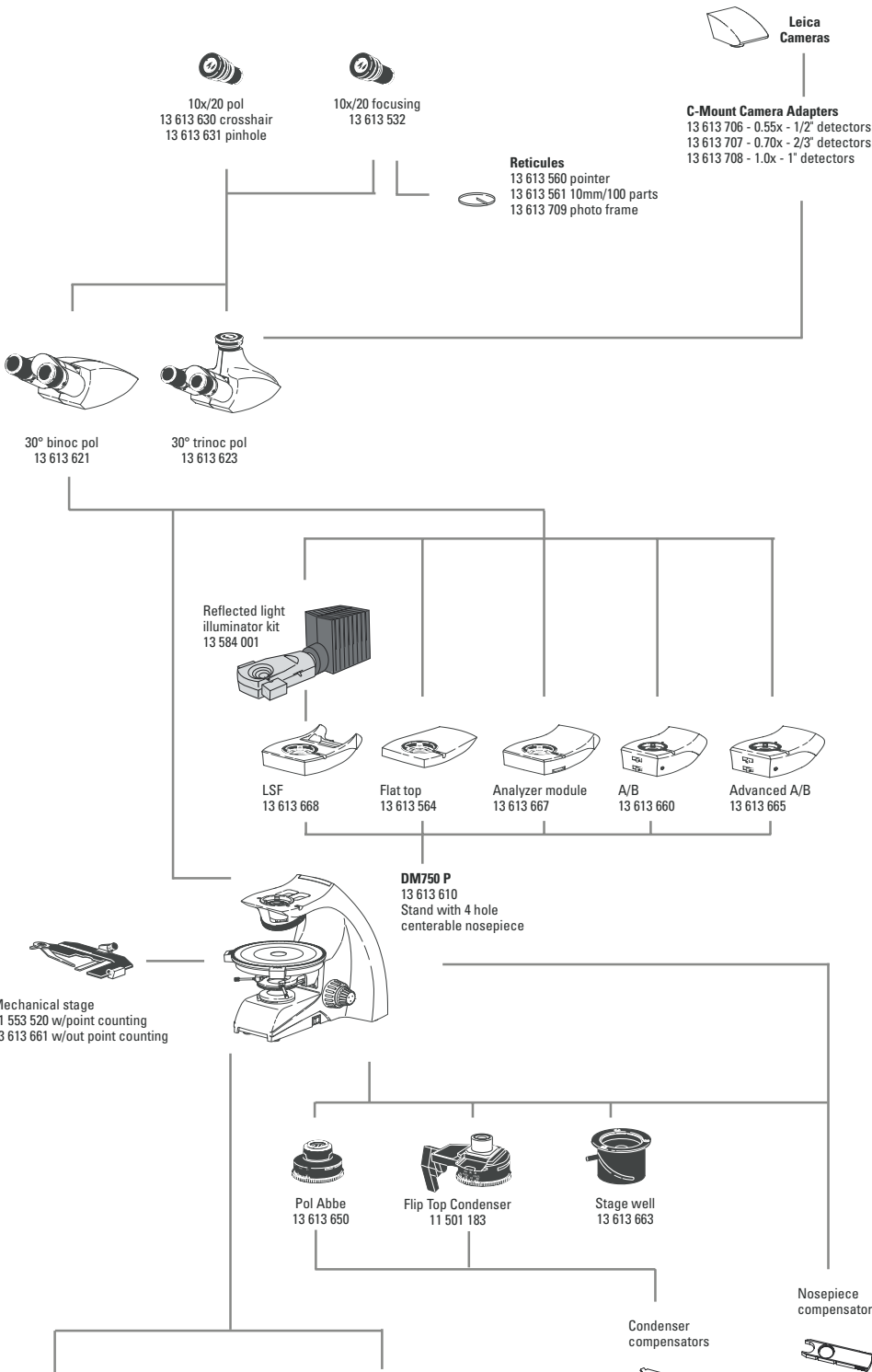

HI Plan Pol FOV 20

- 11 556 060 - HI Plan Pol 4x/0.10 NA, 18.0mm*
 - 11 556 061 - HI Plan Pol 10x/0.25 NA, 12.0mm*
 - 11 556 065 - HI Plan Pol 40x/0.65 NA, 0.36mm*
 - 11 556 066 - HI Plan Pol 63x/0.75 NA, 0.31mm*
 - 11 556 511 - HI Plan Pol DS 10x/0.25 NA, 12.0mm*
 - 11 556 512 - HI Plan Pol DS 40x/0.65 NA, 0.36mm*
- * working distance

N Plan Pol FOV 22 for Reflected Light

- 11 556 036 - N Plan Pol 2.5x/0.07 NA, 11.2mm*
 - 11 556 075 - N Plan Pol 5x/0.12 NA, 14mm*
 - 11 556 070 - N Plan Pol 10x/0.25 NA, 17.6mm*
 - 11 556 072 - N Plan Pol 20x/0.40 NA, 1.15mm*
 - 11 556 073 - N Plan Pol 50x/0.75 NA, 0.50mm*
 - 11 556 053 - N Plan Pol 100x/1.25 NA, 0.12mm*, Oil
- * working distance

- 11 555 074 Lambda
- 13 586 008 1/4 Lambda

Nosepiece compensators

- 13 586 006 Lambda
- 13 586 007 1/4 Lambda

- 11 553 188 Quartz wedge

- 11 553 180 Tilting Compensator B Compensator
- 11 553 182 Tilting Compensator K Compensator
- 11 553 185 Brace-Koehler Compensator

Analyzer Module Sliders

- 11 555 045 Fixed Analyzer Slider
- 11 555 079 180° Rotatable Analyzer Slider
- 11 555 080 360° Rotatable Analyzer Slider

Reflected Light

- 13 584 001 Reflected Light Illuminator Kit (Req. 13613668 for use on DM500, DM750, DM750 P stands) consists of:
 - 11 505 122 - LSF Reflected Light Illuminator
 - 11 501 179 - Power Supply
 - 11 504 030 - Lamphouse Adapter
 - 11 504 080 - Lamphouse
 - 11 500 974 - 100Watt Halogen Lamp
 - 11 513 858 - Brightfield Cube
 - 11 513 835 - Pol/Analyzer Cube
 - 11 514 755 - Daylight Blue Filter - 50mm in mount
- Power cord must be ordered separately

Additional cubes for Reflected Light

- 11 101 582 Pol only Cube
- 13 583 890 Bertrand Lens Cube













Replacements

- 13 613 563 Eyeguard Pair
- 13 WFAG30001 Fuse for DM750 P
- 13 586 000 Blue Filter for DM750 P
- 13 596 030 35 Watt Halogen Lamp for DM750 P
- 11 500 974 100 Watt Halogen Lamp for Reflected Light Kit
- 13 613 662 Objective Centering Tools
- 13 613 671 Thumbscrew pair DM750 P condenser mount
- 13 583 041 Object clamps for DM750 P
- 13 613 610-100 DM750 P User Documents
- 13 586 062 Add-on lens for condensers (included with stand)
- 13 613 669 Dust cover for DM750 P

Others

- 11 513 106 Stage Micrometer
- 11 505 091 Diffuser Slider for using 2.5X objective with Abbe Condensers
- 11 505 507 Auxilliary lens for using 2.5X objective with 11501183 Flip top Condenser

International power cords

- 13 613 900 U.S. 
- 13 613 901 Europe Continental 
- 13 613 902 U.K. 
- 13 613 903 Switzerland 
- 13 613 904 Denmark 
- 13 613 905 Italy 
- 13 613 906 Australia 
- 13 613 907 China 
- 13 613 908 Japan 
- 13 613 909 Israel 
- 13 613 910 South Africa 
- 13 613 911 India 
- 13 613 912 Argentina 

Leica DM750 P Specifications

Separate Eyepieces

High eyepoint
10x/20 (20mm Field of View)
Crosshair eyepiece with 45° marks, scale, and orientation feature
Available fixed or focusing
Focusing eyepieces with reticle holder for 21mm reticle
Foldable eyeguards
30mm mounting diameter

Viewing Tubes for separate eyepieces

30° Pol binocular & trinocular tube with slot for alignment, 90° and 45° orientation feature on right eyetube for crosshair eyepiece
Maximum field of view 20mm
Leica tube dovetail standard
Eyepiece locking screw on left eyetube
Interpupillary distance range 52mm – 75mm

Stand

Stand shape protects controls
Stand construction – die cast aluminium
External fuses
Knurled nosepieces
4 position centerable nosepieces
ISO Compensator position above nosepieces
Pin in stand for alignment of pol viewing tubes

EZStore™

Vertical handle
Undercut in front of stand
Cord wrap
Vertical cord attachment to stand
Storage positions in A/B Modules for 2 compensators and objective centering tools
Magnetic attachment for objective centering tool storage
Detent attachment for compensator storage

Objectives

Infinity Platform
HI Plan Pol for FOV 20
Objective labeling laser engraved
M25 nosepiece thread

EZGuide™

Point counting and non point counting mechanical stages (stage travel 30mm x 40mm)

Stage

Large 178mm circular diameter stage surface
Hard anodized stage surface
Brake for securing rotation location
Laser engraved stage calibration in 1 degree increments
Verniers on two sides to 0.1 degree

Condenser

Centerable and focusable condenser mount
Slot in condenser for contrast sliders (Darkfield, Compensator)
Magnification labels on condenser
Standard Leica condenser mount for condensers (Abbe, Turret, Flip top, etc.)

Focus

Low position focus controls
Self adjusting focus mechanism
300 microns per fine focus rotation
Calibrated in 3 micron increments
Weighted focus knobs

EZLite™

Available with adjustable Koehler field diaphragm as standard
35 Watt Halogen lamp, 2000 hour lamp life
Continuous intensity adjustment
Illumination enough for viewing at lowest intensity

Imaging

Trinocular tubes available (50%/50% light split)
C mount adapters with standard Leica mount

Intermediate Modules

15mm Flat top module
Module for LSF Reflected Light Illuminator

Analyzer/Bertrand Lens Modules

Analyzer module with pin for viewing tube alignment
Basic A/B module with pin for viewing tube alignment
Advanced A/B Module with focusing Bertrand Lens and pin for viewing tube alignment

AgTreat™

Anti Microbial Treatment

Reflected Light

Basic illuminator
Advanced illuminator with aperture and field diaphragms
Selection of cubes for Brightfield, Polarized Light, Bertrand Lens
Selection of fluorescence cubes with a variety of specifications

Certifications

cULus, CE, RoHS



Clean and Green

“With the user, for the user”

Leica Microsystems

Leica Microsystems operates internationally in four divisions, where we rank with the market leaders.

Life Science Division

The Leica Microsystems Life Science Division supports the imaging needs of the scientific community with advanced innovation and technical expertise for the visualization, measurement, and analysis of microstructures. Our strong focus on understanding scientific applications puts Leica Microsystems' customers at the leading edge of science.

Industry Division

The Leica Microsystems Industry Division's focus is to support customers' pursuit of the highest quality end result. Leica Microsystems provide the best and most innovative imaging systems to see, measure, and analyze the microstructures in routine and research industrial applications, materials science, quality control, forensic science investigation, and educational applications.

Biosystems Division

The Leica Microsystems Biosystems Division brings histopathology labs and researchers the highest-quality, most comprehensive product range. From patient to pathologist, the range includes the ideal product for each histology step and high-productivity workflow solutions for the entire lab. With complete histology systems featuring innovative automation and Novocastra™ reagents, Leica Microsystems creates better patient care through rapid turnaround, diagnostic confidence, and close customer collaboration.

Surgical Division

The Leica Microsystems Surgical Division's focus is to partner with and support surgeons and their care of patients with the highest-quality, most innovative surgical microscope technology today and into the future.

The statement by Ernst Leitz in 1907, “with the user, for the user,” describes the fruitful collaboration with end users and driving force of innovation at Leica Microsystems. We have developed five brand values to live up to this tradition: Pioneering, High-end Quality, Team Spirit, Dedication to Science, and Continuous Improvement. For us, living up to these values means: **Living up to Life.**

Active worldwide

Australia:	North Ryde	Tel. +61 2 8870 3500	Fax +61 2 9878 1055
Austria:	Vienna	Tel. +43 1 486 80 50 0	Fax +43 1 486 80 50 30
Belgium:	Groot Bijgaarden	Tel. +32 2 790 98 50	Fax +32 2 790 98 68
Canada:	Richmond Hill/Ontario	Tel. +1 905 762 2000	Fax +1 905 762 8937
Denmark:	Herlev	Tel. +45 4454 0101	Fax +45 4454 0111
France:	Rueil-Malmaison	Tel. +33 1 47 32 85 85	Fax +33 1 47 32 85 86
Germany:	Wetzlar	Tel. +49 64 41 29 40 00	Fax +49 64 41 29 41 55
Italy:	Milan	Tel. +39 02 574 861	Fax +39 02 574 03392
Japan:	Tokyo	Tel. +81 3 5421 2800	Fax +81 3 5421 2896
Korea:	Seoul	Tel. +82 2 514 65 43	Fax +82 2 514 65 48
Netherlands:	Rijswijk	Tel. +31 70 4132 100	Fax +31 70 4132 109
People's Rep. of China:	Hong Kong	Tel. +852 2564 6699	Fax +852 2564 4163
Portugal:	Lisbon	Tel. +351 21 388 9112	Fax +351 21 385 4668
Singapore		Tel. +65 6779 7823	Fax +65 6773 0628
Spain:	Barcelona	Tel. +34 93 494 95 30	Fax +34 93 494 95 32
Sweden:	Kista	Tel. +46 8 625 45 45	Fax +46 8 625 45 10
Switzerland:	Heerbrugg	Tel. +41 71 726 34 34	Fax +41 71 726 34 44
United Kingdom:	Milton Keynes	Tel. +44 1908 246 246	Fax +44 1908 609 992
USA:	Bannockburn/Illinois	Tel. +1 847 405 0123	Fax +1 847 405 0164

and representatives in more than 100 countries

In accordance with the ISO 9001 certificate, Leica Microsystems (Switzerland) Ltd, Industry Division, has at its disposal a management system that meets the requirements of the international standard for quality management. In addition, production meets the requirements of the international standard ISO 14001 for environmental management.